

Avion

HIGH PERFORMANCE
FURNITURE FOR YOUR
HOME THEATER



Avion™ Home Theater Furniture

www.bdiusa.com
customerservice@bdiusa.com

Your Avion™ Home Theater Furniture is engineered for easy assembly. Carefully follow this procedure to prevent any damage.

Placement and Maintenance

Avion™ Home Theater Furniture is designed for indoor use on level floors. Clean glass with glass cleaner, and steel parts and wood veneer with a moist cloth.

Designed by BDI Design Studio.

'Avion' is a trademark of Becker Designed, Inc. All rights reserved. ©2007 Becker Designed, Inc.

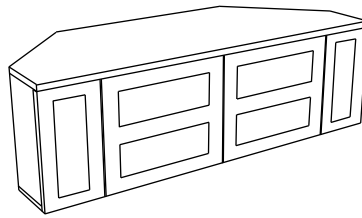

A - Avion Cabinet

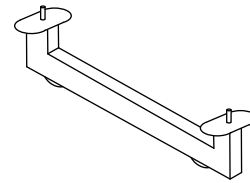

B - Metal Leg x 2



C - Machine Screw x 8

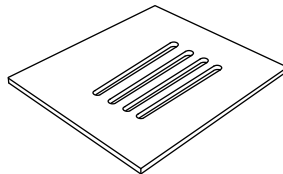

D - Adjustable Shelf x 2

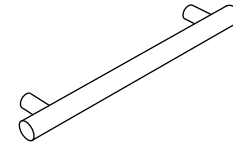

E - Handle x 2



F - Handle Screw x 4

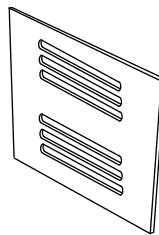

G - Back Panel x 2



H - M4 Hex Wrench

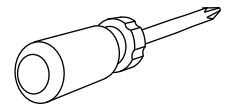

I - Phillips Screwdriver

Step 1

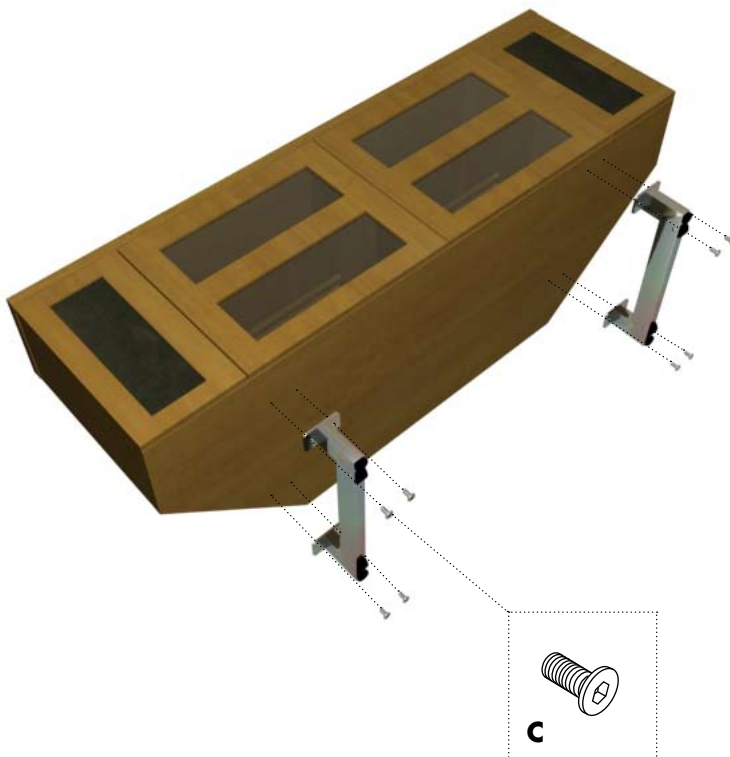

Unpack and identify the parts listed above.

The assembly workspace should be a non-marring surface such as carpet. For missing hardware pieces, please contact BDI Customer Service at: customerservice@bdiusa.com For all other concerns please contact your local BDI Retailer.

Install legs.

First, remove all internal components from the cabinet including shelves, hardware box, and metal legs. Carefully tip cabinet onto its back (Step 1). **Install metal legs (B)** to the bottom of the cabinet using **machine screw (C)** and **M4 hex wrench (H)**. *Note: Each of the metal legs have adjustable levelers that can be tuned from inside the cabinet.

For more information about the adjustable levelers and troubleshooting assembly, be sure to check out "Fine tuning your new BDI Avion Home Theater Furniture" at the end of these instructions.

Step 2

Adjustable shelf pins are pre-installed inside the cabinet. Depending on the height of your component, you may raise or lower the shelf to a desired level.

Install adjustable shelf (D) inside the left and right cabinet area. *Note: In order to place the adjustable shelf inside cabinet, the shelf must be tilted sideways to clear the door.

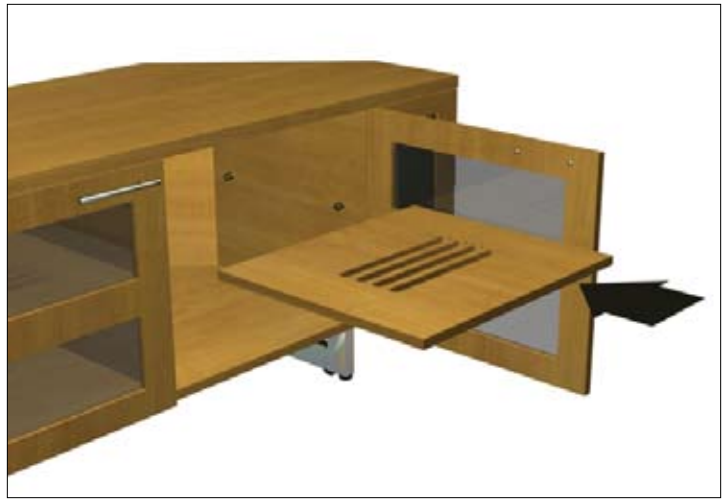

Step 3

Install handles (E) on doors using the **handle screw (F)** and a **Philips screw driver**.

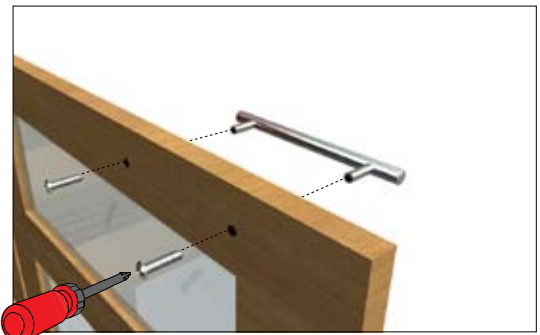
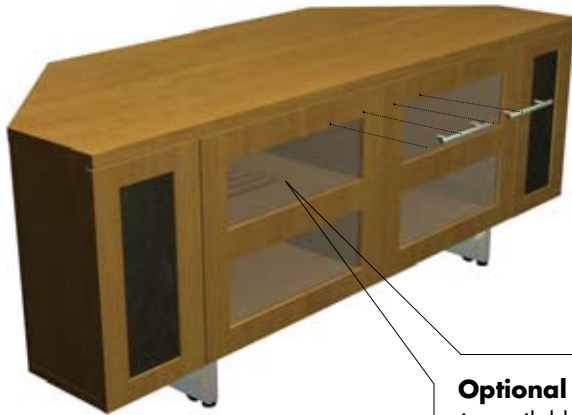

Detail: rear view of door.

Optional Fabric Speaker Insert Panel is available. Contact BDI Customer Service at: customerservice@bdiusa.com

Step 4

Install back panels (G) to the rear side of cabinet.



Fine tuning your new BDI Avion Home Theater Furniture

These steps are to be followed after you have unpackaged and completed the simple assembly instructions for your Avion or Avion Noir stand. Due to jostling in freight or perhaps an uneven floor, the doors and drawers on your Avion stand may not appear to be in perfect alignment. Making a few minor adjustments can rectify this situation. Be aware that depending on your situation, patience and a bit of trial and error are required. The high-quality European hinge hardware is infinitely adjustable, but changing one element can cause the need for further adjustments. Through a little adjustment, you can modify the orientation of the cabinet doors to make sure that they are sitting perfectly on your Avion unit.



INCORRECT! Door is out of alignment with the rest of the unit.



CORRECT! Door is sitting squarely and evenly spaced on tops and sides.

STEP 1 - Level your Avion unit (if needed)

The levelers which are concealed within the legs can be adjusted from inside the Avion cabinet to compensate for an uneven floor or to secure your cabinet so that it does not roll. If you are having difficulty with misaligned doors, it is recommended that you first retract all levelers and make sure that the unit is resting on it's wheels. If the center section on a three-legged unit appears to be sagging (center doors hangs below the side doors) raise the levelers on the center leg to compensate for this.



STEP 2 - Adjust Door Hinges (if needed)

The doors on your Avion stand should be perfectly spaced and the doors should open and close freely without rubbing against the door frame. Adjustments may be made to the Avion door hinges with the use of a Phillips head screwdriver. The hinge hardware has three adjustment screws.

- By adjusting **Screw 1**, the door will move left and right within the frame. For best results, make minor adjustments to top and bottom hinge for best results.
- If adjusting Screw 1 has not achieved the desired result, you can adjust **Screw 2** and the door will move up and down within the frame (the top and bottom hinges need to be adjusted the same amount).
- Adjusting **Screw 3** will cause the entire door to move in and out, opening and closing the gap between the door frame and cabinet. This screw rarely needs adjustment.

